

Varenummer: 0101123
 Beskrivelse: Seeger låsering A 150 DIN 471
 Fjederstål
 Note: Monteres med ZGA tang

Mål

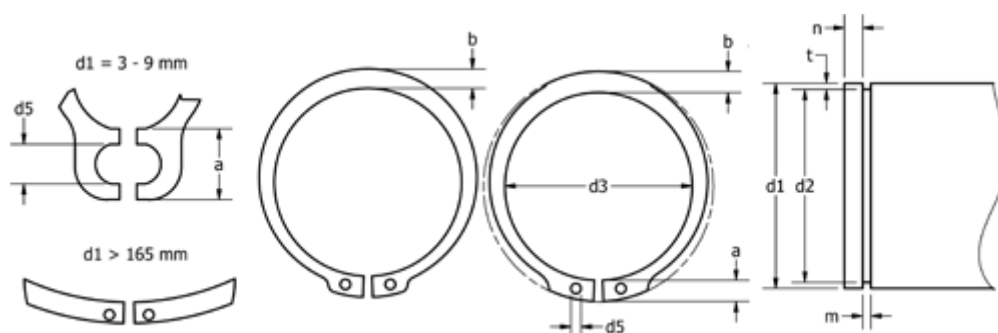

a max	= 13,0	FN kN	= 193.0	s	= 4.00
AN mm ²	= 1158.0	FRg kN	= 53.40	t	= 2.50
b	= 11.8	FR kN	= 357.00	Tang	= ZGA-5
Betegnelse	= A150	g	= 4.0	tol	= -0.10
d1	= 150	K kN-mm	= 825.00	tol	= +0,63-1,50
d2	= 145.0	m min	= 4.15	tol	= -0.63
d3	= 142.0	n abl x 1000	= 2.0	vægt kg/1000	= 120.000
d5 min	= 4.0	Nominel træk	= 7.5		